

The background features a stylized globe with a grid of latitude and longitude lines, overlaid with a network of glowing blue and white lines that suggest data flow and connectivity. The overall color palette is dominated by various shades of blue, from light cyan to deep navy.

**netsys**

*Networking your world*

**NV-720R**

**ADSL2+/VDSL2 Modem Router**

**USER'S MANUAL**

[Http://www.netsys.com.tw](http://www.netsys.com.tw)



## Copyright

Copyright © 2017 by National Enhance Technology Corp. All rights reserved.

### Trademarks

NETSYS is a trademark of National Enhance Technology Corp.

Other brand and product names are registered trademarks or trademarks of their respective holders.

### Legal Disclaimer

The information given in this document shall in no event be regarded as a guarantee of conditions or characteristics. With respect to any examples or hints given herein, any typical values stated herein and/or any information regarding the application of the device, National Enhance Technology Corp. hereby disclaims any and all warranties and liabilities of any kind, including without limitation warranties of non-infringement of intellectual property rights of any third party.

### Statement of Conditions

In the interest of improving internal design, operational function, and/or reliability, NETSYS reserves the right to make changes to the products described in this document without notice. NETSYS does not assume any liability that may occur due to the use or application of the product(s) or circuit layout(s) described herein.

Maximum signal rate derived from IEEE Standard specifications. Actual data throughput will vary. Network conditions and environmental factors, including volume of network traffic, building materials and construction, and network overhead, lower actual data throughput rate. Netsys does not warrant that the hardware will work properly in all environments and applications, and makes no warranty and representation, either implied or expressed, with respect to the quality, performance, merchantability, or fitness for a particular purpose. Make sure you follow in line with the environmental conditions to use this product.

## Foreword: VDSL2 Router solution

### Attention:

Be sure to read this manual carefully before using this product. Especially Legal Disclaimer, Statement of Conditions and Safety Warnings.

Netsys' NV-720R is a management of the VDSL2 CPE router that leverages the extraordinary bandwidth promise of VDSL2 (max. 100Mbps symmetric) technology, the next step in the delivery of new high-speed Internet applications in commercial environments. Quick, easy, economical to install and maintain, the NV-720R works over existing copper wire infrastructure. NV-720R is a CPE (Customer Premise Equipment) device. And compatible with the NV-802S(8Ports VDSL2 IP DSLAM) and NV-720L (VDSL2 Single master(CO) Modem).

Netsys NV-720R will allow operators worldwide to compete with cable and satellite operators by offering services such as HDTV, VOD, videoconferencing, high speed Internet access and advanced voice services including VoIP, over a standard copper telephone cable. Netsys NV-720R is seen by many operators as an ideal accompaniment to a FTTP rollout, where for instance fiber optic is supplied direct to an apartment block and from there copper cable is used to supply residents with high-speed VDSL2.

### Caution:

The NV-720R is for **indoor** applications only. This product does not have waterproof protection, please do not use in outdoor applications.

## Safety Warnings

For your safety, be sure to read and follow all warning notices and instructions before using the device.

- ◆ **DO NOT** open the device or unit. Opening or removing the cover may expose you to dangerous high voltage points or other risks. ONLY qualified service personnel can service the device. Please contact your vendor for further information.
- ◆ **Use ONLY** the dedicated power supply for your device. Connect the power to the right plug type (AC support full range voltage input between 100Vac and 249Vac, 12 VDC/1A or above output).
- ◆ **Place** connecting cables carefully so that no one will step on them or stumble over them. **DO NOT** allow anything to rest on the power cord and do **NOT** locate the product where anyone can work on the power cord.
- ◆ **DO NOT** install nor use your device during a thunderstorm. There may be a remote risk of electric shock from lightning.
- ◆ **DO NOT** expose your device to dampness, dust or corrosive liquids.
- ◆ **DO NOT** use this product near water, for example, in a wet basement or near a swimming pool.
- ◆ **Connect ONLY** suitable accessories to the device.
- ◆ **Make sure** to connect the cables to the correct ports.
- ◆ **DO NOT** obstruct the device ventilation slots, as insufficient air flow may harm your device.
- ◆ **DO NOT** place items on the device.
- ◆ **DO NOT** use the device for outdoor applications directly, and make sure all the connections are indoors or have waterproof protection place.
- ◆ **Be careful** when unplugging the power, because it may produce sparks.
- ◆ **Keep** the device and all its parts and accessories out of the reach of children.
- ◆ **Clean** the device using a soft and dry cloth rather than liquid or atomizers. Power off the equipment before cleaning it.
- ◆ This product is **recyclable**. Dispose of it properly.

**Table of Contents**

**COPYRIGHT..... 1**

**SAFETY WARNINGS ..... 3**

    1.1 CHECK LIST ..... 6

**CHAPTER 2. INSTALLING THE ROUTER..... 7**

    2.1 HARDWARE INSTALLATION ..... 7

    2.2 PRE-INSTALLATION REQUIREMENTS..... 7

    2.3 GENERAL RULES ..... 8

    2.4 CONNECTING THE ROUTER ..... 9

    2.5 CONNECTING THE RJ-11 / RJ-45 PORTS ..... 10

**2.6 VDSL2 APPLICATION ..... 11**

**CHAPTER 3. HARDWARE DESCRIPTION ..... 13**

    3.1 FRONT PANEL..... 14

    3.2 FRONT INDICATORS ..... 14

**3.3 REAR PANEL ..... 15**

**CHAPTER 4. CONFIGURE THE NV-720R VIA WEB BROWSER..... 18**

**4.1 BASIC SETUP ..... 19**

**4.1.1 Login Webpage..... 19**

**4.2 STATUS ..... 20**

**4.2.1 WAN ..... 21**

**4.2.2 Statistics ..... 22**



**NV-720R ADSL2+/ VDSL2 Modem Router USER'S MANUAL Ver. B.6**

**4.3 WAN SETUP** ..... 23

**4.3.1 WAN Interface** ..... 23

**4.3.2 TR-069 settings** ..... 26

**4.3.3 xDSL Configuration** ..... 30

**4.4 SYSTEM** ..... 32

**4.4.1 Update Software** ..... 32

**4.4.2 Restore Default Settings** ..... 33

**4.5 APPLICATIONS** ..... 34

**4.5.1 IGMP Settings** ..... 34

**4.5.2 USB setup** ..... 35

**4.5.3 FTP Server** ..... 36

**4.5.4 FTP Client** ..... 37

**4.5.5 TFTP Server** ..... 38

**4.6 SNMP SETUP** ..... 39

**APPENDIX A: CABLE REQUIREMENTS** ..... 42

**APPENDIX B: PRODUCT SPECIFICATION** ..... 45

**APPENDIX C: ROUTER MODE SELECT** ..... 49

**APPENDIX D: TROUBLESHOOTING** ..... 56

**APPENDIX E: COMPLIANCE INFORMATION** ..... 64

**WARRANTY** ..... 67



**CHINESE SJ/T 11364-2014** ..... 68

## **Chapter 1.** Unpacking Information

### **1.1 Check List**

Carefully unpack the package and check its contents against the checklist.

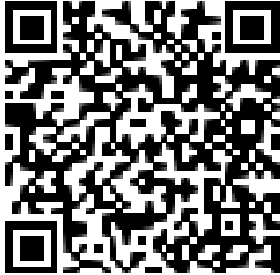
#### **Package Contents:**

			
<p>1 x Managed VDSL2 CPE router</p>	<p>1 x QR code for user's manual hyperlink.</p>	<p>Accessory Kit : 1 x Ethernet Cable, 1 x Phone wire , 1 x DC12V Switching Power Adapter</p>	

#### **Notes:**

1. Please inform your dealer immediately for any missing or damaged parts. If possible, retain the carton including the original packing materials. Use them to repack the unit in case there is a need to return for repair.
2. If the product has any issue, please contact your local vendor.
3. Do not use sub-standard power supply. Before connecting the power supply to the device, be sure to check compliance with the specifications. The NV-720R uses a DC12V/1A power supply.
4. The power supply included in the package is commercial-grade. Do not use in industrial-grade applications.
5. Please look for the QR code on the bottom of the product, the user can launch the QR code scanning program to scan and download the user's manual electronic format file. Above QR code icon is for reference.

## **Chapter 2. Installing the Router**

### 2.1 Hardware Installation

This chapter describes how to install the router, and establish the network connections. The NV-720R may be installed on any level surface (e.g. a table or shelf). However, please take note of the following minimum site requirements before you begin. **The NV-720R has 2 pre-installed rubber feet.**

### 2.2 Pre-installation Requirements

Before you start the actual hardware installation, make sure you can provide the right operating environment, including power requirements, sufficient physical space, and proximity to other network devices that are to be connected.

Verify the following installation requirements:

- Power requirements: **DC 12 V / 1A or above**
- The router should be located in a cool dry place, with at least **10cm/4in** of space at the front and back for ventilation.
- Place the router away from direct sunlight, heat sources, or areas with a high amount of electromagnetic interference.
- Check if the network cables and connectors needed for installation are available.
- **Do not install phone lines strapped together with AC power lines, or telephone office line with voice signal.**
- **Avoid installing this device with radio amplifying stations nearby or transformer stations nearby.**
- **Please note that the voice spectrum allowed by the NV-720R external splitter is 0 KHz ~ 120 KHz.**



## 2.3 General Rules

Before making any connections to the router, please note the following rules:

- **Ethernet Port (RJ-45)**

All network connections to the router Ethernet port must be made using Category 5 UTP/STP or above for 100 Mbps, Category 3, 4 UTP for 10Mbps.

No more than 100 meters of cabling may be use between the MUX or HUB and an end node.

- **VDSL2 Port (RJ-11)**

All network connections to the RJ-11port must use **24~26** gauge with **twisted pair** phone wiring.

We **do not recommend** the use of the telephone line 28 gauge or above.

The RJ-11 connectors have six positions, two of which are wired. The router uses the center two pins. The pin out assignment for these connectors is presented below.

Please note that the line port is no polarity, therefore user can reverse the two wires of the phone cable when installed.

RJ-11 Pin out Assignments

Pin#	MNEMONIC	FUNCTION
1	NC	Unused
2	NC	Unused
<b>3</b>	<b>DSL</b>	<b>Used</b>
<b>4</b>	<b>DSL</b>	<b>Used</b>
5	NC	Unused
6	NC	Unused

## 2.4 Connecting the Router

The router has four Ethernet ports which support connection to Ethernet operation. The devices attached to these ports must support auto-negotiation /10Base-T / 100Base-TX unless they will always operate at half duplex. Use any of the Ethernet ports to connect devices such as Monitor systems, Servers, Switches, bridges or routers.

### **Notes:**

1. The (RJ11) Line port is used to connect the telephone that is connected to VDSL2 CO and CPE router (Point-to-point solution).
2. The Slave device (CPE) must be connected to the Master device (CO) through the telephone wire. The Slave cannot be connected to another Slave, and the Master cannot be connected to another Master.

## 2.5 Connecting the RJ-11 / RJ-45 Ports

- ◆ The line port has 1 connector: RJ-11. It is used to connect with NV-802S(CO) using a single pair phone cable to NV-720R(CPE) bridge side (point to point solution). (Figure 2.1)

**Red Line: Valid**  
**Blake Line: Invalid**

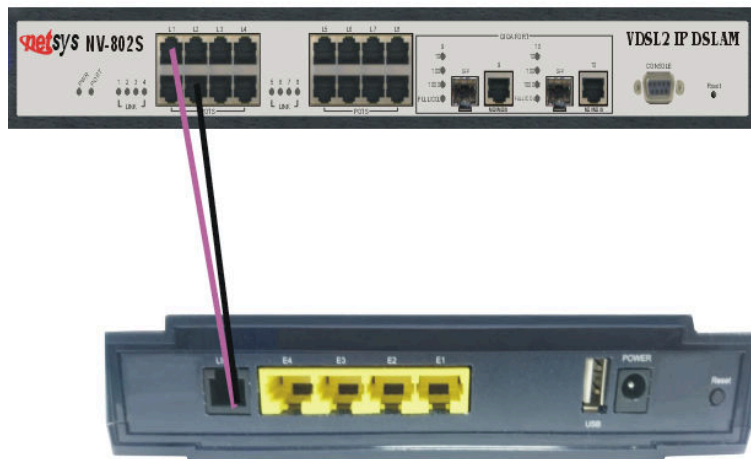

**Figure 2.1 NV-720R line ports straight connectio**

- ◆ When inserting a RJ-11 plug, make sure the tab on the plug clicks into position to ensure that it is properly seated.
- ◆ **Do not** plug a RJ-11 phone jack connector into the Ethernet port (RJ-45 port). This may damage the router. Instead, use only twisted-pair cables with RJ-45 connectors that conform to Ethernet standard.

### **Notes:**

1. Be sure each twisted-pair cable (RJ-45 Ethernet cable) does not exceed 100 meters (333 feet).
2. We advise using Category 5~7 UTP/STP cables for making Bridge or Router connections to avoid any confusion or inconvenience in the future when you attach high bandwidth devices.
3. Use **24 ~ 26** gauge twisted pair phone wiring, we do not recommend 28 gauge or above.
4. Be sure phone wire has been installed before the NV-720R boot.

**2.6 VDSL2 Application**

The router's line port supports up to 3km for data service across existing phone wiring. It is easy-to-use and do not requires installation of additional wiring. Every modular phone jack in the home can become a port on the LAN. Networking devices can be installed on a single telephone wire that can be installed within a suitable distance. (Figure 2.2)

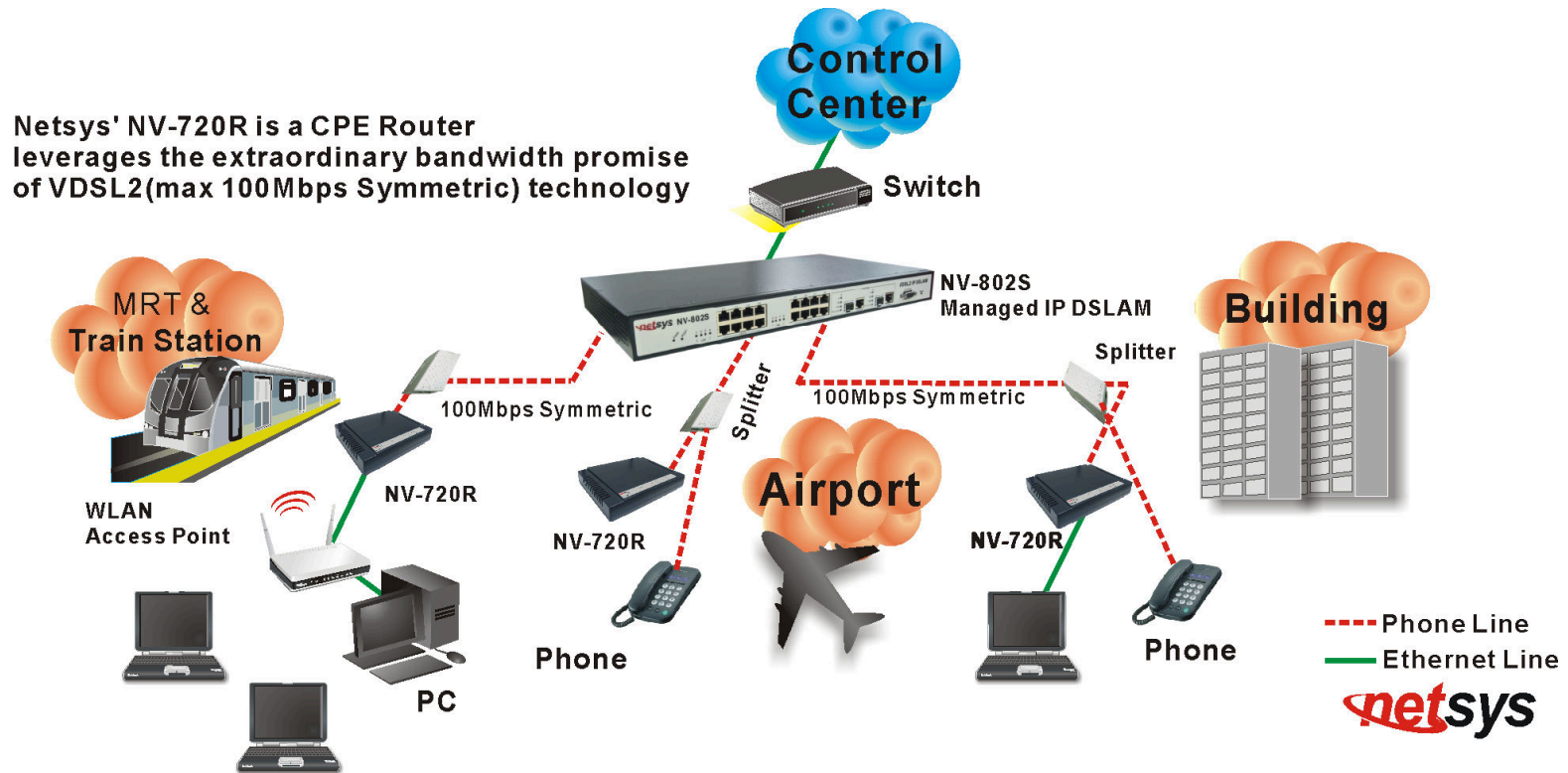

**Figure 2.2 NV-720R application**

◆ **2.6.1 Connect the NV-802S and the NV-720R to the Line**

The objective for VDSL2 is to pass high speed data over a twisted pair cable. In the setup, connect NV-802S to NV-720R through phone wire(24~26 AWG) or line simulator or any other hardware representation of a cable network, with or without noise injection and crosstalk simulations.

◆ **2.6.2 Connect the NV-802S and the NV-720R to LAN Devices**

In the setup, usually an Ethernet tester serves as a representation of the LAN side as well as a representation of the WAN side.

◆ **2.6.3 Run Demos and Tests**

The Ethernet tester may send data downstream as well as upstream. It also receives the data in order to check the integrity of the data transmission. Different data rates can be tested under different line conditions.

## Chapter 3. Hardware Description

This section describes the important parts of the vdsl2 router. It features the front panel and rear panel.



**NV-720R Outward**

### 3.1 Front Panel

The figure shows the front panel. (Figure 3.1)



**Figure 3.1 Front Panel(NV-720R)**

### 3.2 Front Indicators

The router has **Seven** LED indicators. The following Table shows the description. (Table 3-1)

**Table 3-1** LED Indicators Description and Operation

LED	Color	Status	Descriptions
PWR (Power LED)	Green	On(Steady)	Lights to indicate that the VDSL2 router had power
		Off	The device is not ready or has malfunctioned.
USB	Green	On (Steady)	The device has a good USB connection
		Off	The device is not ready or has malfunctioned.
E1 ~ E4 (Ethernet LED)	Green	On(Steady)	The device has a good Ethernet connection.
		Blinking	The device is sending or receiving data.
		Off	The LAN is not connected or has malfunctioned.

LED	Color	Status	Descriptions
LINK (VDSL2 LED)	Green	On(Steady)	The Internet or network connection is up.
		Fast Blinking	The device is sending or receiving data.
		Off	The Internet or network connection is down.

**Note:**

It is normal for the connection between two Routers to take up to 3 minutes, due to NV-802S/NV-720R to establish a link mechanism in auto-negotiation, with detects and calculates CO and CPE both PBO and PSD level, noise levels and other arguments for getting a better connection.

**3.3 Rear Panel**

The following figure shows the rear panel. (Figure 3.2)

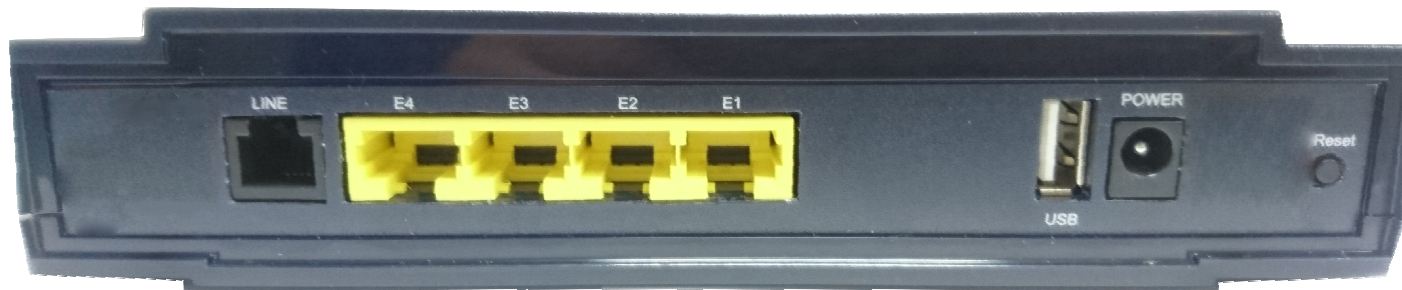

**Figure 3.2 Rear Panel**



And the table shows the description. ([Table 3-2](#))

**Table 3-2** Description of the router rear connectors

Connectors	Type	Description
Reset	Tact switch Button	The reset buttons allows users to reboot the VDSL2 or load the default settings. <b>Press and hold for 1-5 seconds: Reboot the VDSL2 Router</b> <b>Press over 5 seconds: Load the default settings</b>
Power	DC Power Jack	External Power Adapter: Input: AC 100~240Volts/50~60Hz Output: DC 12V/1A
Line	RJ-11	For connecting to a VDSL2 device.
USB	USB2.0 Type A	For connecting to the USB dongle.
Ethernet (E1-E4)	RJ-45	For connecting to an Ethernet equipped device.

**Before user installed power and device, please read and follow these essentials:**

- ◆ Use separate paths to route wiring for power and devices. If power wiring and device wiring paths must cross, make sure the wires are perpendicular at the intersection point.

**Note:**

Do not run signal or communications wiring and power wiring through the same wire conduit. To avoid interference, wires with different signal characteristics should be routed separately.

- ◆ You can use the type of signal transmitted through a wire to determine which wires should be kept separate. The rule of thumb is that wiring sharing similar electrical characteristics can be bundled together.
- ◆ You should separate input wiring from output wiring.
- ◆ We recommend that you mark all equipment in the wiring system.

## **Chapter 4. Configure the NV-720R Via Web Browser**

The NV-720R provides a built-in HTML based management interface that allows configuration of the NV-720R via Internet Browser. Best viewed using Chrome or Firefox browsers.

In order to use the web browser to configure the device, you may need to allow:

- Web browser pop-up windows from your device. Web pop-up blocking is enabled by default in windows XP SP2 or above.
- Java Scripts. (Enabled by default)
- Java permissions. (Enabled by default)

Launch your web browser and input the IP address 192.168.16.254 (NV-720R) in the Web page. Following section user can find default username and password.

## 4.1 BASIC Setup

### 4.1.1 Login Webpage

The IP address is **192.168.16.254** , username and password are **admin**.

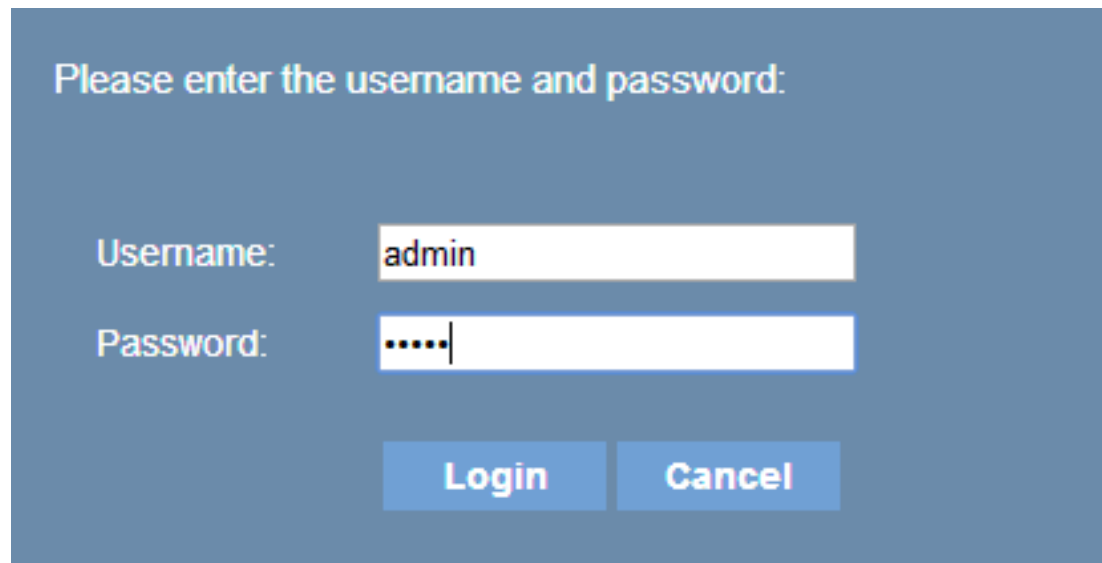

Please enter the username and password:

Username:

Password:

**Figure 4.1 Login Password**

## 4.2 Status

When the device is running, the status page will display device information for Hardware/Software Version, MAC Address, and System Up Time. A screen is displayed as shown in Figure 4.2.



▶ Status	
Quick Setup	
▶ Lan Setup	
▶ Wan Setup	
▶ Advanced Setup	
▶ Applications	
▶ System	
Logout	

### Device Info

Hardware Version:	A.3
Software Version:	B.3.2
MAC Address:	00:05:6e:02:03:06
System Up Time:	0 hours, 52 mins, 27 secs

**Figure 4.2 Device Info**

## 4.2.1 WAN

Select “WAN”, and click on “Network” link in the left navigation bar to check IPv4/IPv6 WAN Connection Status. A screen is displayed as shown in Figure 4.2.1.

**IPv4 WAN Connection Status**

Connection Name	Type	IP Address/Mask	Default Gateway	Primary DNS	Secondary DNS	Status
vdsl	DHCP	192.168.16.64/255.255.255.0	192.168.16.1	192.168.16.1		connected

**IPv6 WAN Connection Status**

Connection Name	Type	IP Address	Default Gateway	Primary DNS	Secondary DNS	Prefix	Status
No Rule Found!							

**DS-Lite Status**

Connection Name	Type	Mode	AFTR Address	Status
No Rule Found!				

**Figure 4.2.1. WAN Connection Status**

## 4.2.2 Statistics

To check xDSL link status, click on the “xDSL” link in the left navigation bar. A screen is displayed as shown in Figure 4.2.2.

The screenshot shows the router's web interface. On the left is a navigation menu with the following items: Status (expanded), Device Information, WAN, LAN, Statistics (expanded), WAN, LAN, WLAN, xTM, xDSL (highlighted), and ARP. Below this are other menu items: Quick Setup, Lan Setup, Wan Setup, Advanced Setup, Applications, System, and Logout. The main content area is titled "Statistics -- xDSL" and contains a table with the following data:

Status:	Up
Line Standard:	G.993.2 /Annex_A
Current Rate(Up/Down):	102409/102393 Kbps
Max Rate(Up/Down):	118571/177816 Kbps
Noise Margin(Up/Down):	8.2/15.7 dB
InterleaveDepth(Up/Down):	19/1
Line Attenuation(Up/Down):	0.8/6.7 dB
Output Power(Up/Down):	8.2/14.2 dBm
FEC(Up/Down):	0/9810
HEC(Up/Down):	0/0
CRC(Up/Down):	0/25804
ESTI.DISTANCE:	123m

Below the table is a "Refresh" button.

**Figure 4.2.2 xDSL Link Status**

## 4.3 WAN Setup

### 4.3.1 WAN Interface

#### 4.3.1.1 Create ATM Mode

Select “WAN Interface” and click on “ATM” link in the left navigation bar and press “Create”.

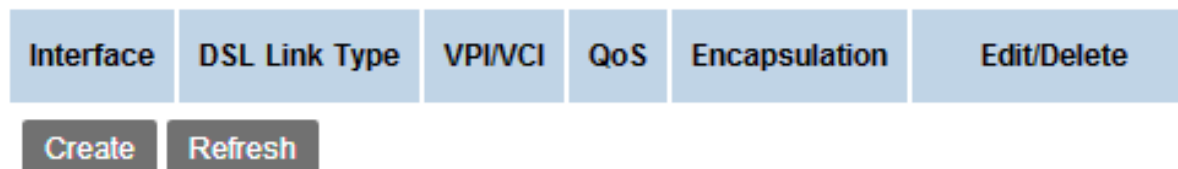
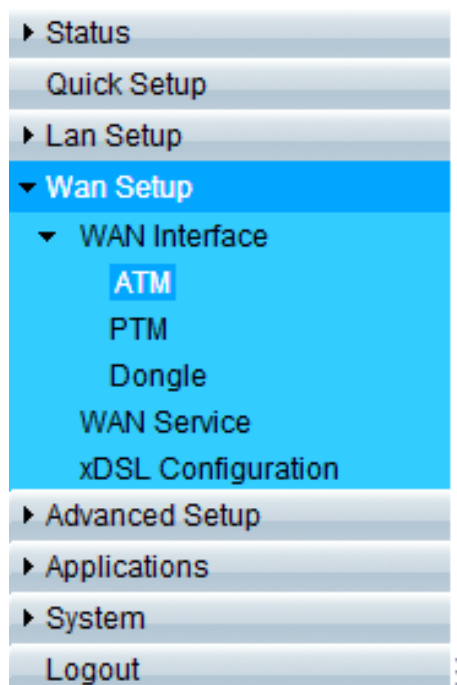
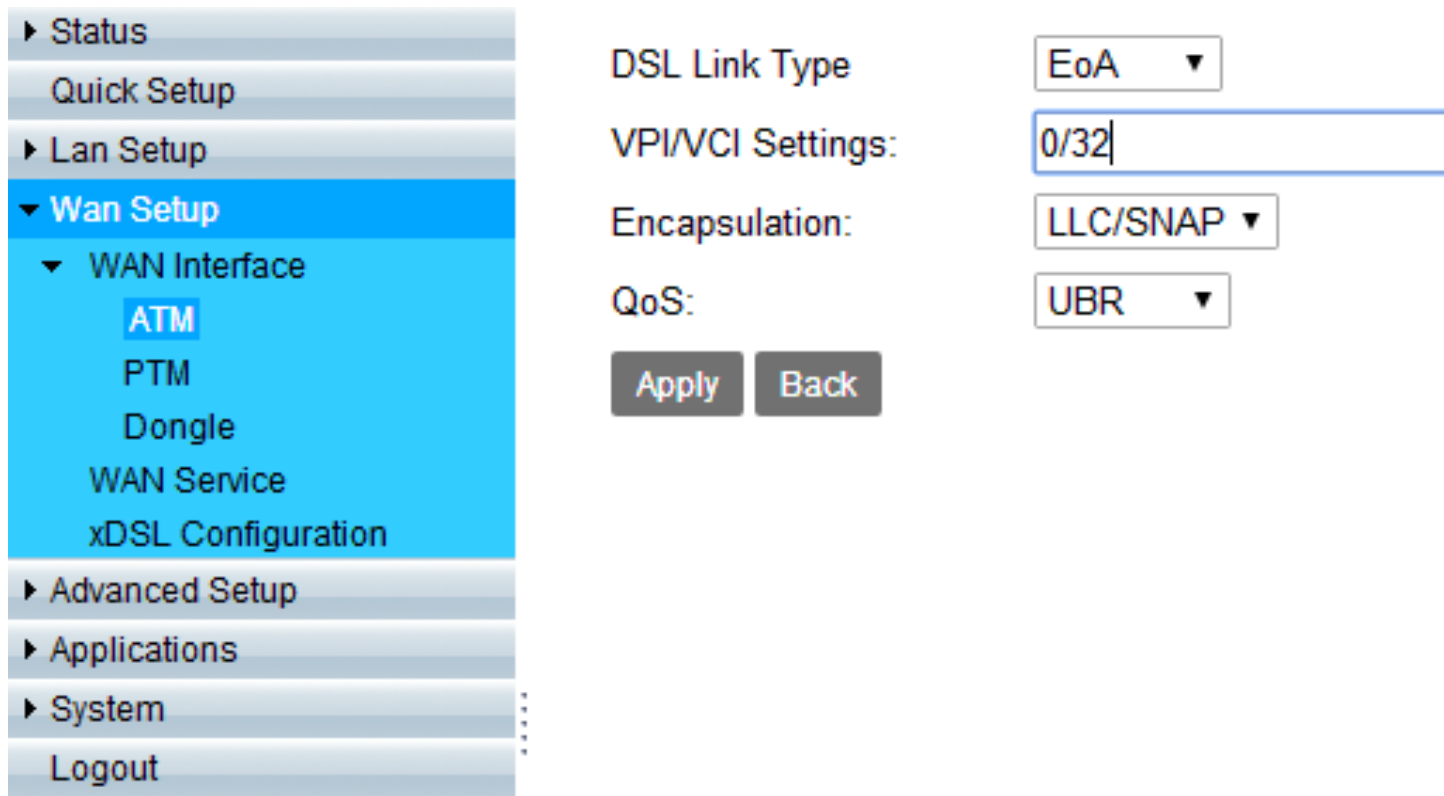

**Figure 4.3.1.1 Create ATM Mode**



### 4.3.1.2 Select ATM Settings

After pressing “Create”, select DSL Link Type, VPI/VCI settings, Encapsulation, and QoS, and press “Apply”, the ATM mode will be successfully created.



**Figure 4.3.1.2 Select ATM Settings**

### 4.3.1.3 ATM Mode Created

After the ATM mode has been created, there will be three interfaces: ATM/PTM/USB in WAN service.

The screenshot shows the WAN Service configuration page. On the left is a navigation menu with 'Wan Setup' expanded to 'WAN Service'. The main area is titled 'WAN ServiceInfo' and contains a table with the following columns: WAN Name, Interface, Mode, IP Protocol Type, Service Type, and Edit/Delete. Below the table is a 'Set New WAN' section with 'Interface' and 'Mode' dropdown menus. The 'Interface' dropdown is currently set to 'ATM\_0\_32' and the 'Mode' dropdown is set to 'ATM'. At the bottom of the 'Set New WAN' section are 'Create' and 'Refresh' buttons.

WAN Name	Interface	Mode	IP Protocol Type	Service Type	Edit/Delete
----------	-----------	------	------------------	--------------	-------------

**Set New WAN**

Interface: ATM\_0\_32 ▼  
Mode: ATM  
PTM  
USB

Create Refresh

**Figure 4.3.1.3 ATM Mode Created**

## 4.3.2 TR-069 settings

### 4.3.2.1 Set New WAN for TR-069

Select “WAN Service” in the left navigation bar to set new WAN, there will be three interfaces now (ATM/PTM/USB). To create PTM +PPPoE WAN Router Connection for TR-069, choose PTM interface & PPPoE mode, and press “Create”.

**WAN ServiceInfo**

WAN Name	Interface	Mode	IP Protocol Type	Service Type	Edit/Delete	
vdsI_PPPoE	PTM	PPPoE	IPv4	TR069_INTERNET	Edit	Delete

**Set New WAN**

Interface:

Mode:

**Figure 4.3.2.1 Set New WAN**

### 4.3.2.2 Setup TR-069 WAN Service Type

Type in the Connection Name and MTU, choose TR069\_Internet for Service Type, and press “Apply”, this WAN Connection can suffer internet and can use TR069.

**WAN Service**

Connection Name:   
 Enable:   
 MTU:   
 IP Protocol Type:   
 NAT:   
 IPv4 Static DNS:   
 PPPoE Type:   
 Servicename:   
 User Name:   
 Password:   
 Authentication Type:   
 Dial Mode:   
 Keep Alive Time:  (10-30)s  
 Keep Alive Max Fail:  (1-100)  
 MAC Address Override:   
 Enable VLAN:   
 Service Type:

[Advanced Settings](#)

**Figure 4.3.2.2 Setup TR-069 WAN Service Type**

### 4.3.2.3 CWMP

Select "System", and click on "CWMP" link in the left navigation bar to create TR-069 connection, and setup ACS URL/ ACS User Name/ACS Password and basic .

**TR069 Settings**

Enable TR069:	<input checked="" type="checkbox"/>
ACS URL:	<input type="text" value="http://acs.demo.co.th:7005/acsmgt"/>
ACS User Name:	<input type="text" value="net"/>
ACS Password:	<input type="password" value="....."/>
Period Inform:	<input checked="" type="checkbox"/>
Inform Interval:	<input type="text" value="86400"/>
Connection Request Authentication:	<input checked="" type="checkbox"/>
User Name:	<input type="text" value="net"/>
Password:	<input type="password" value="....."/>
Connection Request Port:	<input type="text" value="7547"/>
Connection Request URL:	<input type="text" value="/tr069"/>

**Figure 4.3.2.3 TR-069 Settings**



**Warning:** The settings will restore the factory defaults except WAN connection and TR069 Settings.

Confirm WAN service type must be TR-069 or TR069\_INTERNET.

Service Type:

TR069\_INTERNET ▼

### 4.3.3 xDSL Configuration

Select “xDSL Configuration” in the left navigation bar, choose the Link types, Annex versions, and band profiles.

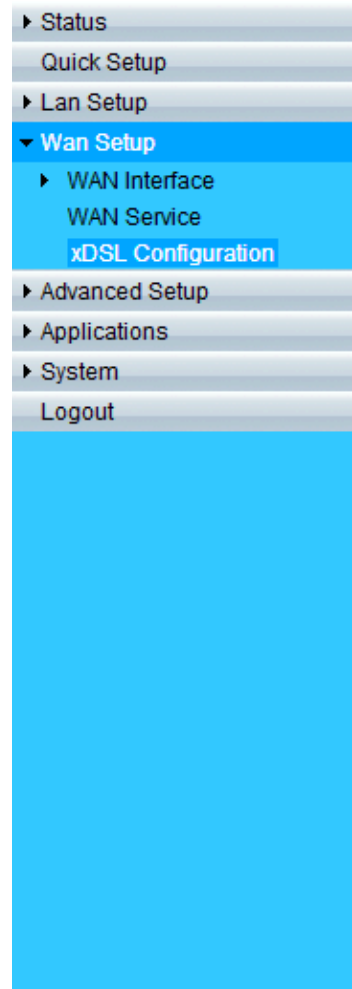

#### WAN - xDSL Configuration

G.DMT	
G.992.1_Annex_A:	<input checked="" type="checkbox"/>
G.992.1_Annex_B:	<input type="checkbox"/>

G.lite	
G.992.2:	<input type="checkbox"/>

T.413	
T1.413:	<input checked="" type="checkbox"/>

ADSL2	
G.992.3_Annex_A:	<input checked="" type="checkbox"/>
G.992.3_Annex_B:	<input type="checkbox"/>
G.992.3_Annex_J:	<input type="checkbox"/>
G.992.3_Annex_L1:	<input checked="" type="checkbox"/>
G.992.3_Annex_L2:	<input checked="" type="checkbox"/>
G.992.3_Annex_M:	<input checked="" type="checkbox"/>

<ul style="list-style-type: none"> <li>▶ Status</li> <li>Quick Setup</li> <li>▶ Lan Setup</li> <li>▼ <b>Wan Setup</b> <ul style="list-style-type: none"> <li>▶ WAN Interface</li> <li>WAN Service</li> <li><b>xDSL Configuration</b></li> </ul> </li> <li>▶ Advanced Setup</li> <li>▶ Applications</li> <li>▶ System</li> <li>Logout</li> </ul>	<table border="1"> <thead> <tr> <th colspan="2" style="background-color: #d9e1f2;">ADSL2+</th> </tr> </thead> <tbody> <tr> <td>G.992.5_Annex_A:</td> <td><input checked="" type="checkbox"/></td> </tr> <tr> <td>G.992.5_Annex_B:</td> <td><input type="checkbox"/></td> </tr> <tr> <td>G.992.5_Annex_J:</td> <td><input type="checkbox"/></td> </tr> <tr> <td>G.992.5_Annex_M:</td> <td><input checked="" type="checkbox"/></td> </tr> </tbody> </table> <table border="1"> <thead> <tr> <th colspan="2" style="background-color: #d9e1f2;">VDSL2</th> </tr> </thead> <tbody> <tr> <td>G.993.2_Annex_A:</td> <td><input checked="" type="checkbox"/></td> </tr> <tr> <td>G.993.2_Annex_B:</td> <td><input checked="" type="checkbox"/></td> </tr> <tr> <td>G.993.2_Annex_C:</td> <td><input checked="" type="checkbox"/></td> </tr> <tr> <td>Profile:</td> <td> <input checked="" type="checkbox"/> 8a                     <input checked="" type="checkbox"/> 8b                     <input checked="" type="checkbox"/> 8c                     <input checked="" type="checkbox"/> 8d  <input checked="" type="checkbox"/> 12a                     <input checked="" type="checkbox"/> 12b                     <input checked="" type="checkbox"/> 17a                     <input checked="" type="checkbox"/> 30a                 </td> </tr> </tbody> </table> <table border="1"> <thead> <tr> <th colspan="2" style="background-color: #d9e1f2;">Capability</th> </tr> </thead> <tbody> <tr> <td>Enable Bitswap:</td> <td><input checked="" type="checkbox"/></td> </tr> <tr> <td>Enable SRA:</td> <td><input checked="" type="checkbox"/></td> </tr> <tr> <td>Enable US0:</td> <td><input checked="" type="checkbox"/></td> </tr> </tbody> </table> <div style="text-align: center;"> <span style="border: 1px solid gray; padding: 2px 10px;">Apply</span> <span style="border: 1px solid gray; padding: 2px 10px; margin-left: 10px;">Refresh</span> </div>	ADSL2+		G.992.5_Annex_A:	<input checked="" type="checkbox"/>	G.992.5_Annex_B:	<input type="checkbox"/>	G.992.5_Annex_J:	<input type="checkbox"/>	G.992.5_Annex_M:	<input checked="" type="checkbox"/>	VDSL2		G.993.2_Annex_A:	<input checked="" type="checkbox"/>	G.993.2_Annex_B:	<input checked="" type="checkbox"/>	G.993.2_Annex_C:	<input checked="" type="checkbox"/>	Profile:	<input checked="" type="checkbox"/> 8a <input checked="" type="checkbox"/> 8b <input checked="" type="checkbox"/> 8c <input checked="" type="checkbox"/> 8d <input checked="" type="checkbox"/> 12a <input checked="" type="checkbox"/> 12b <input checked="" type="checkbox"/> 17a <input checked="" type="checkbox"/> 30a	Capability		Enable Bitswap:	<input checked="" type="checkbox"/>	Enable SRA:	<input checked="" type="checkbox"/>	Enable US0:	<input checked="" type="checkbox"/>
ADSL2+																													
G.992.5_Annex_A:	<input checked="" type="checkbox"/>																												
G.992.5_Annex_B:	<input type="checkbox"/>																												
G.992.5_Annex_J:	<input type="checkbox"/>																												
G.992.5_Annex_M:	<input checked="" type="checkbox"/>																												
VDSL2																													
G.993.2_Annex_A:	<input checked="" type="checkbox"/>																												
G.993.2_Annex_B:	<input checked="" type="checkbox"/>																												
G.993.2_Annex_C:	<input checked="" type="checkbox"/>																												
Profile:	<input checked="" type="checkbox"/> 8a <input checked="" type="checkbox"/> 8b <input checked="" type="checkbox"/> 8c <input checked="" type="checkbox"/> 8d <input checked="" type="checkbox"/> 12a <input checked="" type="checkbox"/> 12b <input checked="" type="checkbox"/> 17a <input checked="" type="checkbox"/> 30a																												
Capability																													
Enable Bitswap:	<input checked="" type="checkbox"/>																												
Enable SRA:	<input checked="" type="checkbox"/>																												
Enable US0:	<input checked="" type="checkbox"/>																												

**Figure 4.3.3 xDSL Configuration**



## 4.4 System

### 4.4.1 Update Software

To update software, click on the “Update Software” link in the left navigation bar, and follow the steps for updating. A screen is displayed as shown in Figure 4.4.1.

**Update Software**

Step 1: Obtain an updated software image file from your ISP.  
Step 2: Enter the path to the image file location in the box below or click the 'Browse' button to locate the image file.  
Step 3: Click the 'Update Software' button once to upload the new image file.

**Note:** The update process takes about 2 minutes to complete, and your Broadband Router will reboot.

Software File Name:  File not found

**Figure 4.4.1 Update Software**

### 4.4.2 Restore Default Settings

To restore broadband router settings to the factory default, select “Logs”, and click on the “Restore Default” link in the left navigation bar. When click “Restore Default Settings”, the device will reboot in 10 seconds. A screen is displayed as shown in Figure 4.4.2.

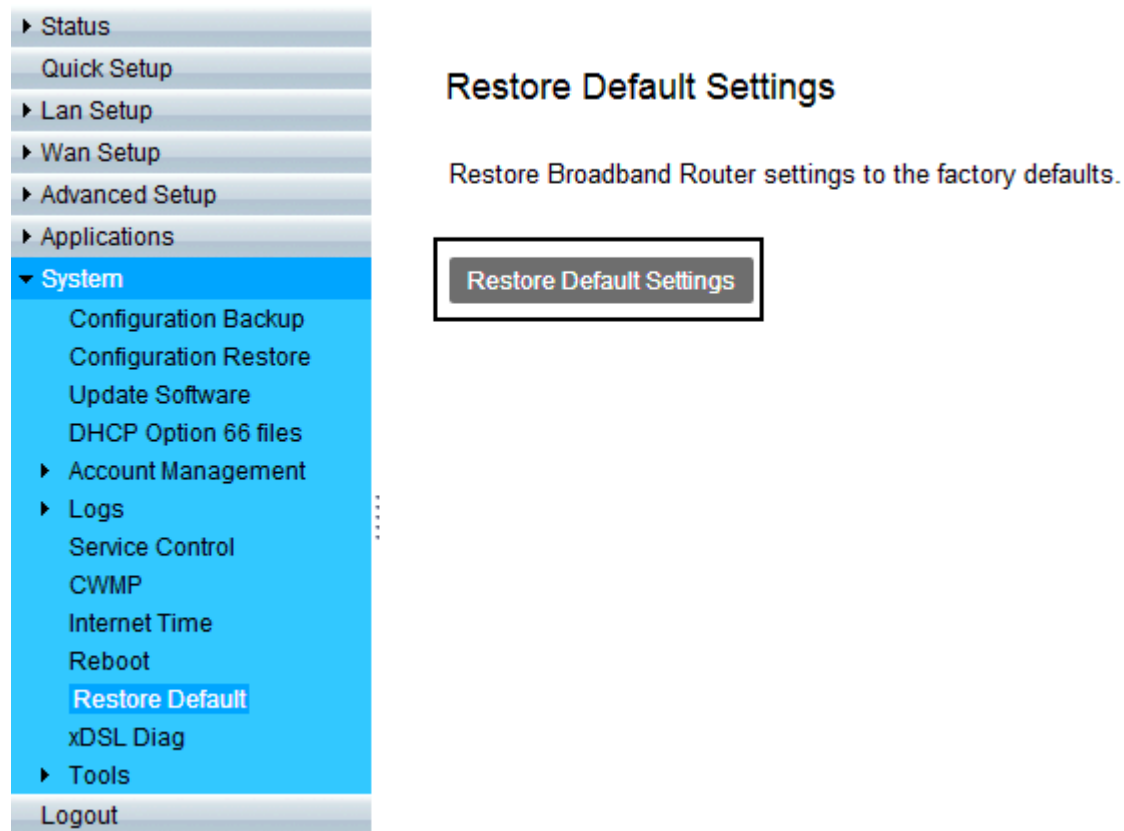

**Figure 4.4.2 Restore Default Settings**

## 4.5 Applications

### 4.5.1 IGMP Settings

Select “Multicast” → “IGMP” link in the left navigation bar. According to the WAN setting, if you want to test IGMP function on Router mode, you only need to enable IGMP function basic on the WAN Setup.

**IGMP Settings**

Enter IGMP protocol configuration fields if you want modify default vaules shown below.  
NOTE: Query Interval is advised to no longer than 125s.

Default Version:

Query Interval(s):

Query Response Interval(1/10s):

Last Member Query Interval(1/10s):

Robustness Value:

Maximum Multicast Data Source(for IGMPv3):

Fast Leave Enable:

Membership Join Immediate(IPTV):

Enable IGMP Snooping:

Enable IGMP Proxy:

WAN Connection	Enable IGMP
vdsl	<input checked="" type="checkbox"/>

**Figure 4.5.1 IGMP Settings**

### 4.5.2 USB setup

Insert a U disk into the USB interface, then login 192.168.1.1, select " Storage Service"->"Storage Device Info" link in the left navigation bar. Confirm the system has mounted the U disk.

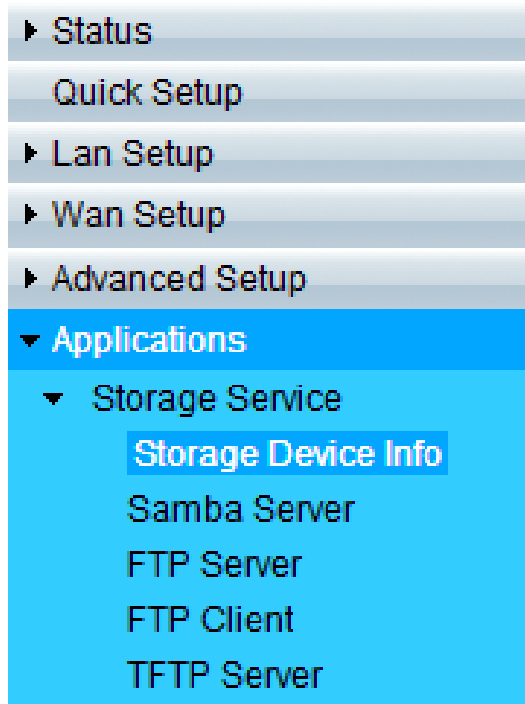

### Storage Device Info

Number	Provider	Product Type	Capacity(MB)
1	FUJITSU	MHV2040AH	39999

**Figure 4.5.2 USB Setup**

### 4.5.3 FTP Server

Select “Storage Device Info” → “FTP Server” link in the left navigation bar, on the right page you will see how to enable FTP Server function.

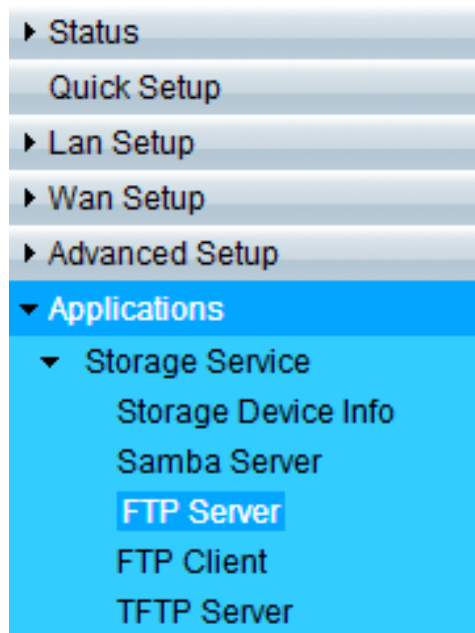

### Storage Service - FTP Service Setup

Note: To enable FTP Server, at least one storage device would be inserted.

Enable FTP Service:

FTP Directory:

Apply

Refresh

**Figure 4.5.3 FTP Service Setup**

### 4.5.4 FTP Client

Select "Storage Device Info" → "FTP Client" link in the left navigation bar, on the right page you can input FTP Client Settings, and click "Download". Then, click "Refresh" to make sure the status is completed.

- ▶ Status
- Quick Setup
- ▶ Lan Setup
- ▶ Wan Setup
- ▶ Advanced Setup
- ▼ Applications
  - ▼ Storage Service
    - Storage Device Info
    - Samba Server
    - FTP Server
    - FTP Client**
    - TFTP Server
  - Telnet Service
  - SSH Service
  - Printer Share
  - Multimedia Share
- ▶ DNS
  - UPnP
- ▶ Multicast
  - SNMP
- ▶ VPN
- ▶ System
- Logout

#### Storage Service - FTP Client Settings

User Name:

Password:

Download URL:

Port:

Device:

Save Path:

#### The latest 10 download records

User Name	Password	Port	Download URL	Save Path	Progress	Status	Action
blake		21	ftp://netsys.com.tw/hello.htm	xdown	100%	complete	<input type="button" value="Delete"/>

The latest 10 download records

**Refresh**

User Name	Password	Port	Download URL	Save Path	Progress	Status	Action
blake		21	ftp://netsys.com.tw/hello.htm	xdown	100%	complete	Delete

**Figure 4.5.4 FTP Client Settings**

### 4.5.5 TFTP Server

Select “Storage Device Info” → “TFTP Server” link in the left navigation bar, on the right page you will see how to enable TFTP Server function.

- ▶ Status
- Quick Setup
- ▶ Lan Setup
- ▶ Wan Setup
- ▶ Advanced Setup
- ▼ Applications
  - ▼ Storage Service
    - Storage Device Info
    - Samba Server
    - FTP Server
    - FTP Client
    - TFTP Server**

#### Storage Service - TFTP Service Setup

Note: To enable the TFTP Server, a storage device may be needed.

Enable TFTP Service:

TFTP Directory:

**Figure 4.5.5 TFTP Service Setup**

## 4.6 SNMP setup

Click on “SNMP” link in the left navigation bar, on the right page you will see how to enable SNMP function. NV-720R supports SNMP V1/V2.

**SNMP Settings**

Enable SNMP	<input checked="" type="checkbox"/>
System Contact	<input type="text" value="net"/>
System Name	<input type="text" value="net"/>
System Location	<input type="text" value="net"/>
Public community	<input type="text" value="public"/>
Private community	<input type="text" value="private"/>
Trap Enable	<input type="checkbox"/>
Trap Version	<input type="text" value="SNMP V1"/>
Trap Address	<input type="text" value="192.168.1.100"/>

**Figure 4.6 SNMP Settings**



Download “MG-SOFT MIB Browser”. below is picture for how to use the software.  
Connect Remote SNMP agent.

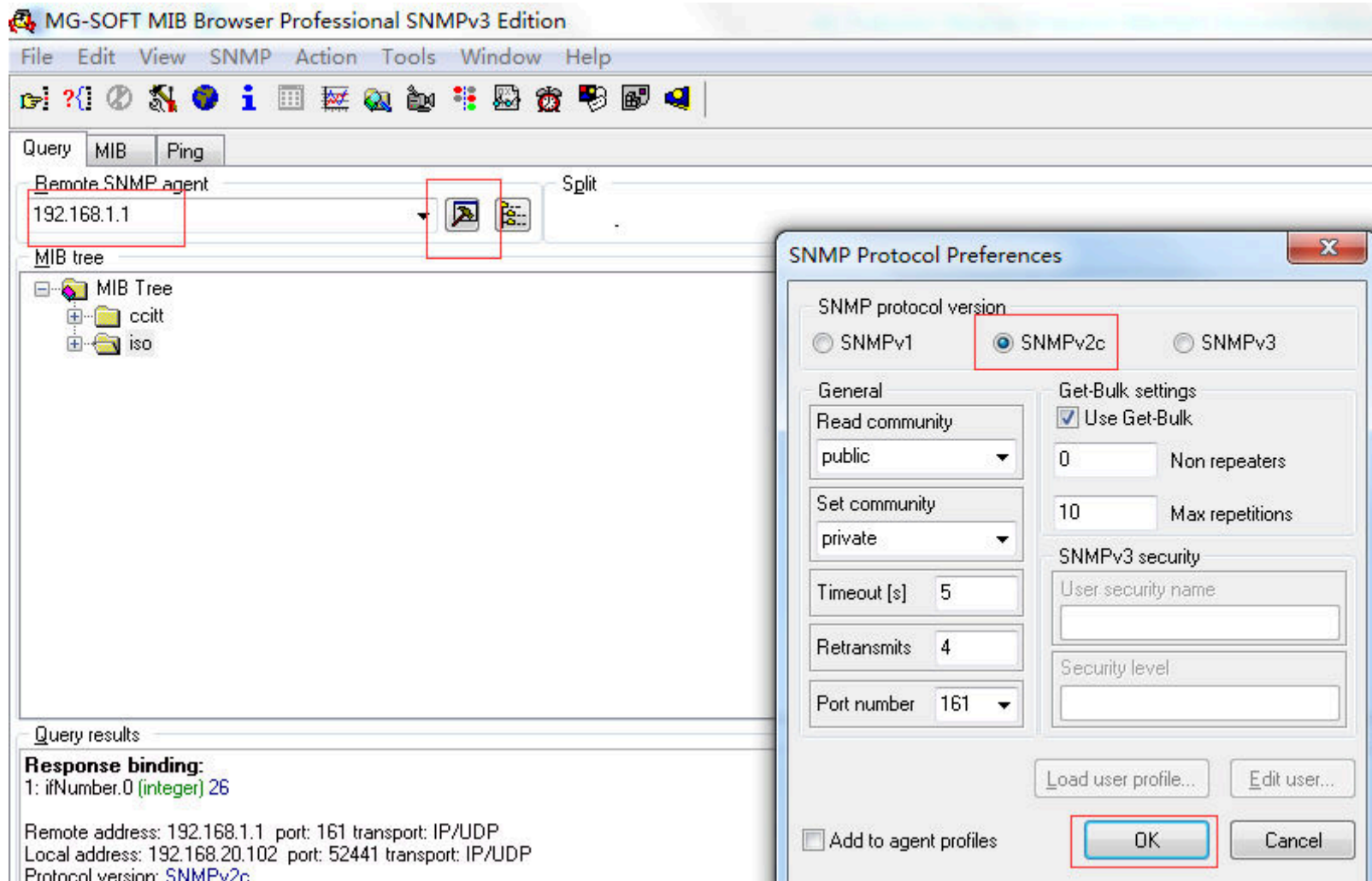

Select OID:1.3.6.1.2.1.1.3  
System Up Time

Query MIB Ping

Remote SNMP agent  
192.168.1.1

MIB tree

- MIB Tree
  - ccitt
  - iso
    - org
      - dod
        - internet
          - directory
          - mgmt
            - mib-2
              - system
                - sysDescr
                - sysObjectID
                - sysUpTime
                - sysContact
                - sysName
                - sysLocation

Query results

```
***** SNMP QUERY STARTED *****
1: sysUpTimeInstance (timeticks) 0 days 16h:52m:37s.13th (6075713)
***** SNMP QUERY FINISHED *****

Remote address: 192.168.1.1 port: 161 transport: IP/UDP
Local address: 192.168.20.102 port: 64685 transport: IP/UDP
Protocol version: SNMPv2c
1: sysUpTimeInstance (timeticks) 0 days 16h:53m:09s.53th (6078953)
```

## **Appendix A: Cable Requirements**

### **A.1 Ethernet Cable**

A CAT 3~7 UTP (unshielded twisted pair) cable is typically used to connect the Ethernet device to the router. A 10Base-T cable often consists of four pairs of wires, two of which are used for transmission. The connector at the end of the 10Base-T cable is referred to as an RJ-45 connector and it consists of eight pins. The Ethernet standard uses pins 1, 2, 3 and 6 for data transmission purposes. (Table A-1)

**Table A-1** RJ-45 Ethernet Connector Pin Assignments

PIN #	MDI		MDI-X	
	Signal	Media Dependant interface	Signal	Media Dependant interface-cross
1	TX+	Transmit Data +	RX+	Receive Data +
2	TX-	Transmit Data -	RX-	Receive Data -
3	RX+	Receive Data +	TX+	Transmit Data +
4	--	Unused	--	Unused
5	--	Unused	--	Unused
6	RX-	Receive Data -	TX-	Transmit Data -
7	--	Unused	--	Unused
8	--	Unused	--	Unused

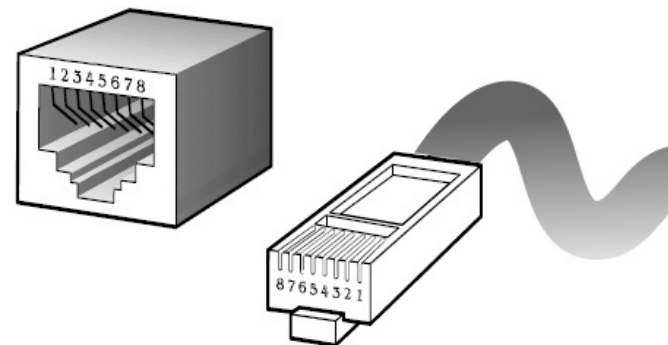

**Figure A-1** Standard RJ-45 repeater/connector

**Note:**

Please make sure your connected cables have the same pin assignment as the table above before deploying the cables into your network.

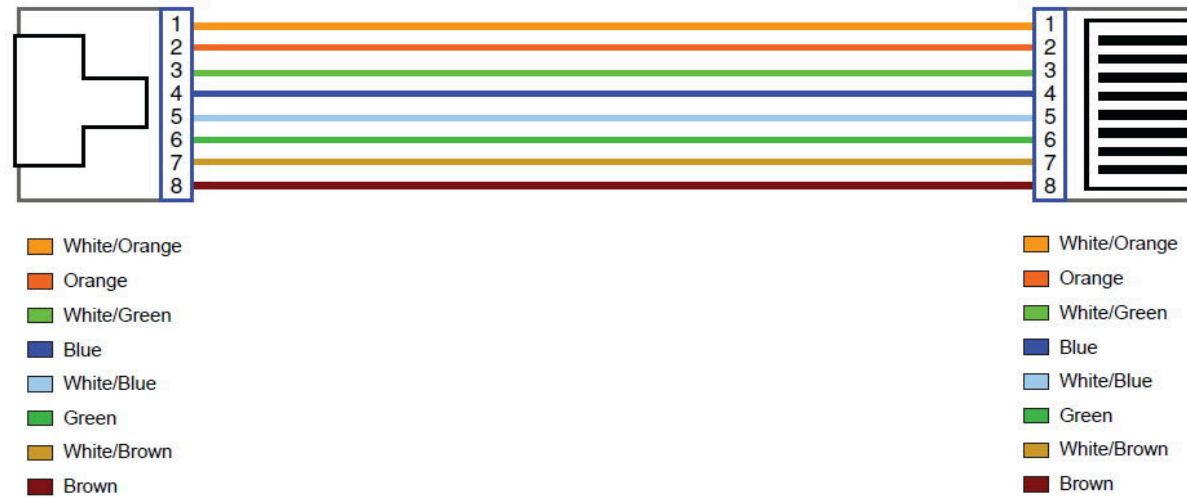

**Figure A-2 Pin Assignments and Wiring for an RJ-45 Straight-Through Cable**

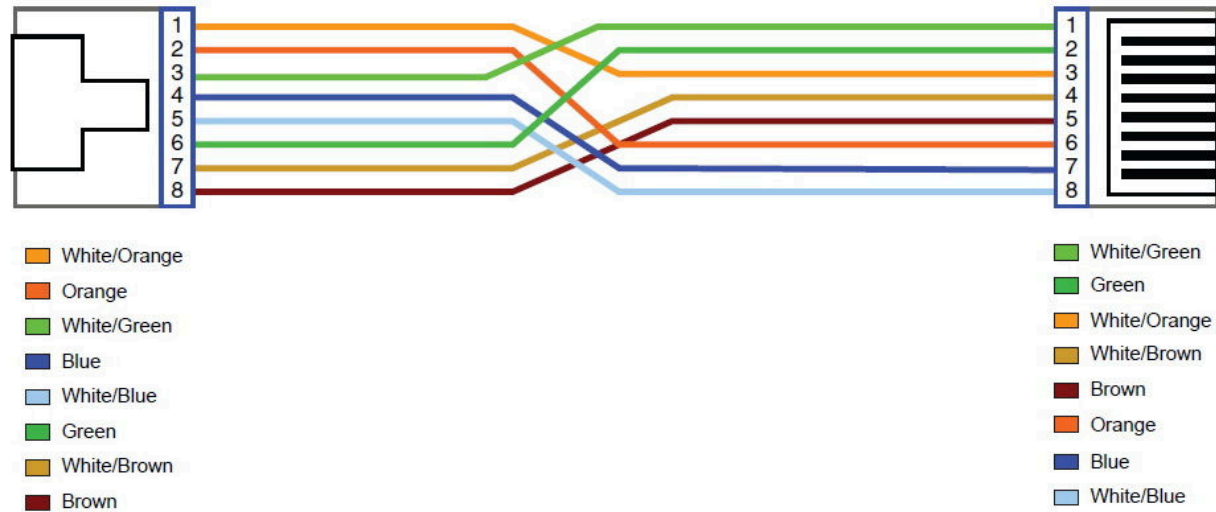

**Figure A-3 Pin Assignments and Wiring for an RJ-45 Crossover Cable**

**A.2 Telephone wire**

Standard telephone wire of any gauge or type-flat, twisted or quad is used to connect the Modem to the telephone network. A telephone cable typically consists of three pairs of wires, one of which is used for transmission. The connector at the end of the telephone cable is called an RJ-11 connector and it consists of six pins. POTS (plain old telephone services) use pins 3 and 4 for voice transmission. A telephone cable is shown below. (Figure A-4)

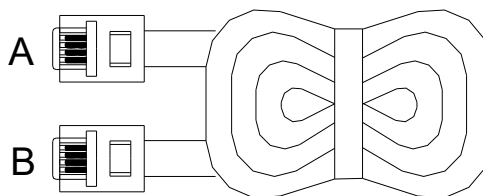

**Figure A-4 Telephone cable**

The A and B connectors on the rear of the Modem are RJ-11 connectors. These connectors are wired identically. The RJ-11 connectors have six positions, two of which are wired. The Modem uses the center two pins. The pin out assignment for these connectors is presented below. (Table A-2)

**Table A-2 RJ-11 Pin out Assignments**

Pin#	MNEMONIC	FUNCTION
1	NC	Unused
2	NC	Unused
<b>3</b>	<b>TIP</b>	<b>POTS</b>
<b>4</b>	<b>RING</b>	<b>POTS</b>
5	NC	Unused
6	NC	Unused

## **Appendix B: Product Specification**

### **Key Features & Benefits**

- ◆ Adopts ARM Cortex A9 dual-core processor
- ◆ Supports G.993.5 Vectoring and ADSL2+
- ◆ Supports G.998.4 G.INP
- ◆ Supports Dying Gasp
- ◆ Support ATM and PTM transmission mode auto detection (ADSL backward compatible)
- ◆ Supports high bandwidth up to 100Mbps symmetric over line ports
- ◆ Support 997, 998 band plan with Annex A / Annex B selection by web
- ◆ Support 8a, 8b, 8c, 8d, 12a, 12b, 17a, 17b, and 30a band profile with auto follow-up CO side
- ◆ Support Annex A / Annex B selection by web
- ◆ Support ATM-TC, ATM and AAL5 (ATM Flow Throughout / OAM Cell Filter and Forwarding / AAL5 SAR:PVC / ATM Traffic Class / ATM PVC Shaping / ATM PVC Scheduling)
- ◆ Supports ATM Total Upstream Priority Queues
- ◆ Support uPnP/PPPoE/PPPoATM/IPv4/IPv6/NAT/NAPT
- ◆ Support static routing for IPv4 and IPv6 forwarding
- ◆ Support Firewall functions contains Packet filtering, DMZ, Mac Address based filtering, Parental Control, Application based filtering
- ◆ Support DHCP Server/DHCP Relay/DHCP Client/DHCPv6 Client/DHCPv6 Server/DNS/DNS Proxy or Relay/DNSv6 Proxy or Relay/NTP Client/HTTP1.1 server
- ◆ Support Multicast IP table/IGMP v3 Proxy and Snooping

- ◆ Supports IEEE 802.1q VLAN tagging
- ◆ Support IEEE 802.1p VLAN Priority and mapping to DSCP
- ◆ Support 8 queue MFC/DSCP both type QoS
- ◆ Supports HTTP/HTTPS web management
- ◆ Support SSL / SSH security
- ◆ Support remote management and monitor
- ◆ Support configuration backup and restore
- ◆ Provides surge protection for Line port
- ◆ Support Router & Switch(Bridged) mode selection
- ◆ Supports Dual Firmware Image Backup
- ◆ Supports SNMP v2
- ◆ Supports TR-069
- ◆ Supports VPN
- ◆ Supports Jumbo frame(MTU) up to 2k bytes

**Note:**

1. Features and specifications in this manual are subject to change without prior notice.
2. (\*) Firmware upgradeable for future enhancement.

**Product Specification**

<b>Standard:</b>	IEEE802.3/802.3u standards ITU-T G992.1/G992.3/G992.5/G993.1/ G993.2/ G993.5/G997.1/G998.4 standards
<b>Regulatory Compliance:</b>	FCC CE RoHS compliance
<b>Physical Interface:</b>	4 x RJ-45 10/100 Mbps auto-negotiation Ethernet port 1 x RJ-11 connector for VDSL2 line port 1 x Reset Button for resetting to factory default 1 x USB2.0 for connecting USB dongle
<b>LED Indicators:</b>	1 x Power LED 4 x Link/Active Status for Ethernet port 1 x Link LED for VDSL2 port 1 x USB LED
<b>Switch method:</b>	Store and forward
<b>Flow control:</b>	Full duplex: IEEE 802.3x Half duplex: Back pressure
<b>Typical Power Consumption:</b>	3 W
<b>Power Supply:</b>	Input Voltage: 12 VDC (Commerical-grade power adapter)
<b>Operating Temperature:</b>	0°C ~ 50°C (32°F ~ 122°F) Fanless, free air cooling





<b>Storage Temperature:</b>	-20°C ~ 70°C (-4°F ~158°F)
<b>Humidity:</b>	10% to 90% (non-condensing)
<b>Dimensions:</b>	184 x 146 x 40 mm ( 7.2" x 5.74" x 1.57")
<b>Weight:</b>	0.4 kg
<b>EMC:</b>	EMI Compliant: FCC EMS Compliant: CE mark

## Appendix C: Router Mode select

This appendix describes how to select the router mode, The NV-720R default mode is switch(bridged mode), please refer to the following steps to select the router mode or switch mode.

### ◆ Select the Router mode:

1. To configure the router mode settings, click the **IPv4 Configuration** link (**LAN Setup**) on the left navigation bar. Then select the "Server" at the DHCP Mode, and click Apply at any time during configuration to save the information that you have entered. A screen is displayed as shown in [Figure C.1](#)

The screenshot shows the IPv4 Configuration page. On the left is a navigation menu with 'IPv4 Configuration' highlighted. The main content area has the following fields and options:

- IP Address: 192.168.16.154
- Subnet Mask: 255.255.255.0
- Primary DNS Server: 192.168.16.154
- Secondary DNS Server: (empty)
- Domain Name: localhost
- Radio buttons:  Disable DHCP,  Enable DHCP Relay,  Enable DHCP Server
- Relay IP: 192.168.16.1
- Start(PC): 192.168.1.2
- End(PC): 192.168.1.254
- Lease Time: 86400 (Seconds)
- Buttons: Edit Reserved IP Address, Edit Dhcp Option 60, Edit Dhcp Options
- Lan Port Map:  LAN1  LAN2  LAN3  LAN4
- Buttons: Apply, Refresh

**Figure C-1 DHCP Server**

2. Click the **WAN Service** link (**WAN Setup**) on the left navigation bar to specify the WAN Setup. Please Select as the DHCP Mode.

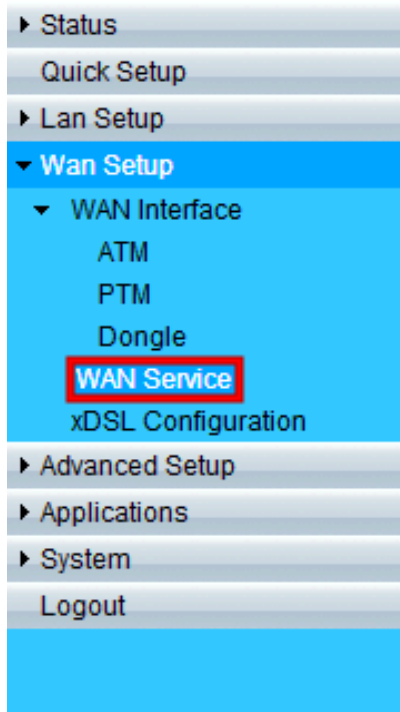

### WAN ServiceInfo

WAN Name	Interface	Mode	IP Protocol Type	Service Type	Edit/Delete	
vdsI_PPPOE	PTM	PPPoE	IPv4	TR069_INTERNET	Edit	Delete

### Set New WAN

The screenshot shows the 'Set New WAN' configuration form. The 'Interface' dropdown is set to 'PTM'. The 'Mode' dropdown is open, showing options: DHCP (selected), Static, PPPoE, and Bridge. A 'Create' button is visible below the form.

**Figure C-2 WAN Setup**

3. Please refer to the **section 4.2** to configure the wan type, the user can setup the Dynamic IP Address, Static IP Address, PPPoE mode.

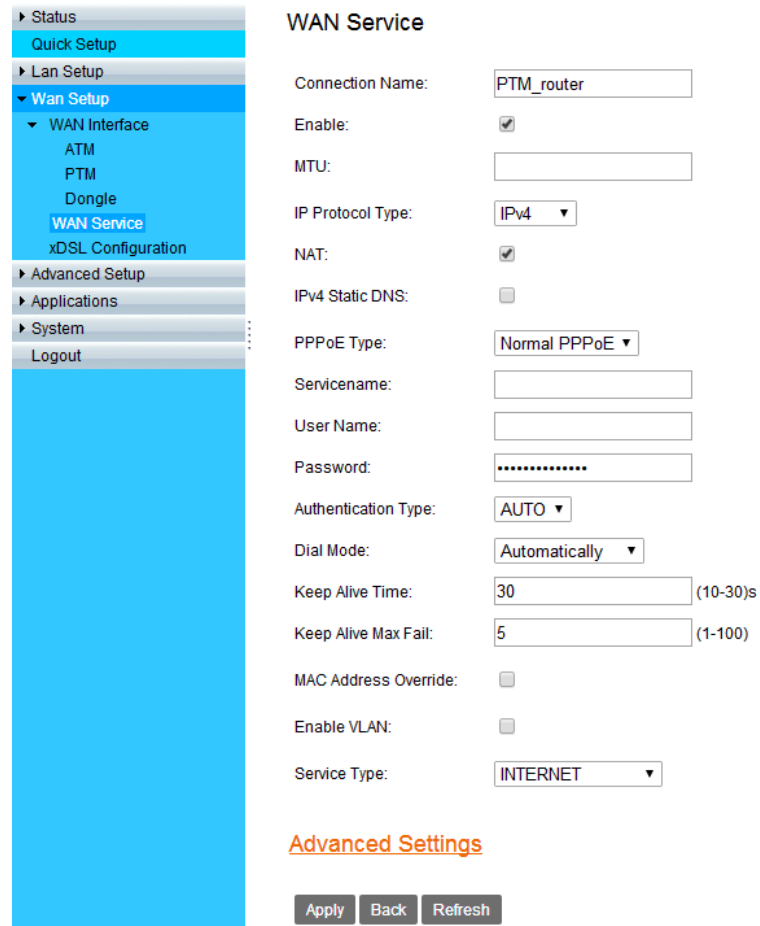

**WAN Service**

Connection Name:

Enable:

MTU:

IP Protocol Type:

NAT:

IPv4 Static DNS:

PPPoE Type:

Servicename:

User Name:

Password:

Authentication Type:

Dial Mode:

Keep Alive Time:  (10-30)s

Keep Alive Max Fail:  (1-100)

MAC Address Override:

Enable VLAN:

Service Type:

[Advanced Settings](#)

**Figure C-3 Config WAN Type**

- ◆ Click **Apply** for applying the changes.
- ◆ Click **Back** to exit from this page without saving the changes.

■ **Select the Bridged mode:**

1. To configure the bridged mode settings, click the **IPv4 Configuration** link (**LAN Setup**) on the left navigation bar. And click Apply at any time during configuration to save the information that you have entered. A screen is displayed as shown in [Figure C.4](#)

**IPv4 Configuration**

IP Address: 192.168.16.234

Subnet Mask: 255.255.255.0

Primary DNS Server: 192.168.16.234

Secondary DNS Server:

Domain Name: localhost

Disable DHCP
  Enable DHCP Relay
  Enable DHCP Server

Relay IP: 192.168.16.1

Start(PC): 192.168.1.2

End(PC): 192.168.1.254

Lease Time: 86400 (Seconds)

Edit Reserved IP Address

Edit Dhcp Option 60 Edit Dhcp Options

Apply Refresh

**Figure C-4 DHCP Mode – Disable**

2. Click the **WAN Service** link (**WAN Setup**) on the left navigation bar to specify the WAN setup. A screen is displayed as shown in Figure C.5

**WAN ServiceInfo**

WAN Name	Interface	Mode	IP Protocol Type	Service Type	Edit/Delete
----------	-----------	------	------------------	--------------	-------------

**Set New WAN**

Interface:

Mode:

- ▶ Status
- Quick Setup
- ▶ Lan Setup
- ▼ Wan Setup
  - ▶ WAN Interface
    - WAN Service
    - xDSL Configuration
- ▶ Advanced Setup
- ▶ Applications
- ▶ System
- Logout

## WAN Service

Connection Name:

Enable:

IP Protocol Type:

Enable VLAN:

Service Type:

### Advanced Settings

Static Route Setting

Connection Name:	LAN ▾
Enable:	<input checked="" type="checkbox"/>
Destination Subnet:	0.0.0.0
Subnet Mask:	0.0.0.0
Gateway:	192.168.16.1
Metrics:	1

Back Apply Refresh

**Figure C-5 WAN Setup**



## Appendix D: Troubleshooting

### Diagnosing the Router's Indicators

The router can be easily monitored through its comprehensive panel indicators. These indicators assist the network manager in identifying problems the hub may encounter. This section describes common problems you may encounter and possible solutions.

<b>1. Symptom:</b>	POWER indicator does not light up (green) after power on.
<b>Cause:</b>	Defective External power supply
<b>Solution:</b>	Check the power plug by plugging in another that is functioning properly. Check the power cord with another device. Check the terminal block make sure to fasten the power cord. If these measures fail to resolve the problem, have the unit power supply replaced by a qualified distributor.
<b>Note:</b>	Please refer to power status table to check power input status. Section 3.3
<b>2. Symptom:</b>	Link indicator does not light up (green) after making a connection.
<b>Cause:</b>	Network interface (ex. a network adapter card on the attached device), network cable, or switch port is defective.
<b>Solution:</b>	2.1 Power off and re-power on the VDSL2 router. 2.2 Verify that the switch and attached device are power on. 2.3 Be sure the cable is plugged into both the switch and corresponding device. 2.4 Verify that the proper cable type is used and its length does not exceed specified limits. 2.5 Check the router on the attached device and cable connections for possible defects. 2.6 Make sure that the phone wire must be connecting NV-720R first, when powered on. 2.7 Replace the defective router or cable if necessary.

<b>3. Symptom:</b>	VDSL Link cannot be established.
<b>Cause:</b>	VDSL setting failure or phone cable length is over the specification limit.
<b>Solution:</b>	<p>3.1 Please make sure that the phone wire must be connected between CO side and NV-720R (CPE) when both are power on. CO side will do link speed function depending on phone wire length, therefore if CO side can't detect NV-720R (CPE) over phone wire while both power on, this will cause the link to fail.</p> <p>3.2 Please check phone wire, we recommend use 24-26 gauge with twisted pair and without rust.</p> <p>3.3 Please reinsert power when change cable length or link time over 3 minutes.</p>
<b>Note:</b>	Phone wire must meet CAT 3 standard or above and <b>without clustering</b> , otherwise will cause more cross talk issue to reduce DSL power driver.

<b>4. Question:</b>	What is VDSL2? (Only reference)
<b>Answer:</b>	<p>Very-high-speed digital subscriber line 2 (VDSL2) is an access technology that exploits the existing infrastructure of copper wires that were originally deployed for traditional telephone service. It can be deployed from central offices, from fiber-optic connected cabinets located near the customer premises, or within buildings. It was defined in standard ITU-T G.993.2 finalized in 2005.</p> <p>VDSL2 was the newest and most advanced standard of digital subscriber line (DSL) broadband wireline communications. Designed to support the wide deployment of triple play services such as voice, video, data, high definition television (HDTV) and interactive gaming, VDSL2 was intended to enable operators and carriers to gradually, flexibly, and cost-efficiently upgrade existing xDSL infrastructure.</p>

The protocol was standardized in the International Telecommunication Union telecommunications sector (ITU-T) as Recommendation G.993.2. It was announced as finalized on 27 May 2005,[1] and first published on 17 February 2006. Several corrections and amendments were published in 2007 through 2011.

VDSL2 is an enhancement to very-high-bitrate digital subscriber line (VDSL), Recommendation G.993.1. It permits the transmission of asymmetric and symmetric aggregate data rates up to 200 Mbit/s downstream and upstream on twisted pairs using a bandwidth up to 30 MHz.

VDSL2 deteriorates quickly from a theoretical maximum of 250 Mbit/s at source to 100 Mbit/s at 0.5 km (1,600 ft) and 50 Mbit/s at 1 km (3,300 ft), but degrades at a much slower rate from there, and still outperforms VDSL. Starting from 1.6 km (1 mi) its performance is equal to ADSL2+.

ADSL-like long reach performance is one of the key advantages of VDSL2. LR-VDSL2 enabled systems are capable of supporting speeds of around 1–4 Mbit/s (downstream) over distances of 4–5 km (2.5–3 miles), gradually increasing the bit rate up to symmetric 100 Mbit/s as loop-length shortens. This means that VDSL2-based systems, unlike VDSL1 systems, are not limited to short local loops or MTU/MDUs only, but can also be used for medium range applications.

<b>5. Question:</b>	What is SNR(Signal-to-Noise)? (Only reference)
<b>Answer:</b>	<p>Signal-to-noise ratio (often abbreviated SNR or S/N) is a measure used in science and engineering that compares the level of a desired signal to the level of background noise. It is defined as the ratio of signal power to the noise power. A ratio higher than 1:1 indicates more signal than noise. While SNR is commonly quoted for electrical signals, it can be applied to any form of signal (such as isotope levels in an ice core or biochemical signaling between cells). The ratio is usually measured in decibels(dB)</p> <p>The signal-to-noise ratio, the bandwidth, and the channel capacity of a communication channel are connected by the Shannon–Hartley theorem.</p> <p>In digital communications, the SNR will probably cause a reduction in data speed because of frequent errors that require the source (transmitting) computer or terminal to resend some packets of data. SNR measures the quality of a transmission channel over a network channel. The greater the ratio, the easier it is to identify and subsequently isolate and eliminate the source of noise.</p>
<b>6. Symptom:</b>	Connected the CO Router with CPE Router within 300 meters RJ-11 phone cable got only less than 10 Mbit/s.
<b>Cause:</b>	Some testing program which is base on TCP/IP protocol such as FTP, Iperf, NetIQ, the bandwidth of testing outcome will be limited by TCP window size.
<b>Solution:</b>	We recommend to test VDSL2 bandwidth best by Smartbit equipment, if you don't have Smartbit, we recommend test that by IPERF program, and TCP window size must be settled max. 64k, the parameter as iperf –c server IP address –i 1 –t 50 –w 65535 for client side.

<b>7. Question:</b>	I just bought a Netsys NV-720R to replace my Quest DSL modem for my home. I was told any VDSL2 modem would replace and give me higher communication speeds. It doesn't get me internet when hooked up. All lights come on but no Link light. Is this the complete wrong application for this unit?
<b>Answer:</b>	Re: Please note NV-720R is a remote side(CPE side), it must be connected to the CO side to work. Tone mode, Band profile and band plan setting must be compatible to each other if not access error will show when applied. Please deactivate and activate once the setting has been changed.

<b>8. Question:</b>	We need to set up a default gateway on a NV-720 pair which are in Bridge mode, as they want to manage the units from a different network.
<b>Answer:</b>	<p>When the application is used within the LAN, the switch(bridged) mode is not necessary to set up a gateway .However, if the application crosses various network segments (LAN to WAN or WAN to LAN), you must set up a gateway to connect different network segment.</p> <p>Regarding how to configure a default gateway at switch(bridged) mode for crossing various network segments .</p> <p>Configuration gateway example from static routing:            Destination LAN IP: 0-0-0-0            Subnet Mask: 0-0-0-0            Gateway: 255-255-255-0</p> <p><b>Note:</b> Static Routing functionality is used to define the connected Gateway between the LAN and WAN.</p>

<b>9. Question:</b>	Is it possible to use ADSL2 IP DSLAM with the NV-720R?
<b>Answer:</b>	NV-720R support the ADSL backward compatible, therefore the NV-720R can connect to ADSL2 IP DSLAM(Annex B).

<b>10. Question:</b>	What can I do if I forgot my password.
<b>Answer:</b>	If you forgot your password, you must reset your router. Unfortunately this process will change all your settings back to the factory defaults. To reset the router, locate the reset on the rear panel of the unit. With the router powered on, use a paperclip to hold the button down for over 5 seconds. Release the button and the router will go through its reboot process. The default ip is 192.168.16.254. When logging in, the default username and password both are "admin".

<b>11. Question:</b>	What is the maximum Ethernet frame MTU for these routers?
<b>Answer:</b>	NV-720R maximum Ethernet frame MTU is 2000 bytes(Jumbo Frame).

## System Diagnostics

### Power and Cooling Problems

If the POWER indicator does not turn on when the power cord is plugged in, you may have a problem with the power outlet, power cord, or internal power supply as explained in the previous section. However, if the unit power is off after running for a while, check for loose power connections, power losses or surges at the power outlet. If you still cannot isolate the problem, then the internal power supply may be defective. In this case, please contact your local dealer.

### Installation

Verify that all system components have been properly installed. If one or more components appear to be malfunctioning (e.g. the power cord or network cabling), test them in an alternate environment where you are sure that all the other components are functioning properly.

### Transmission Mode

The default method of selecting the transmission mode for RJ-45 ports is 10/100 Mbps ETHERNET, for RJ-11 port are auto-negotiation VDSL. Therefore, if the Link signal is disrupted (e.g. by unplugging the network cable and plugging it back in again, or by resetting the power), the port will try to reestablish communications with the attached device via auto-negotiation. If auto-negotiation fails, then communications are set to half duplex by default. Based on this type of commercial-standard connection policy, if you are using a full-duplex device that does not support auto-negotiation, communications can be easily lost (i.e. reset to the wrong mode) whenever the attached device is reset or experiences a power fluctuation. The best way to resolve this problem is to upgrade these devices to a version that support Ethernet and VDSL.

### **Physical Configuration**

If problems occur after altering the network configuration, restore the original connections, and try to track the problem down by implementing the new changes, one step at a time. Ensure that cable distances and other physical aspects of the installation do not exceed recommendations.

### **System Integrity**

As a last resort verify the switch integrity with a power-on reset. Turn the power to the switch off and then on several times. If the problem still persists and you have completed all the preceding diagnoses, then contact your dealer.



## **Appendix E: Compliance Information**

### **FCC Radio Frequency Interference Statement**

This equipment has been tested and found to comply with the limits for a computing device, pursuant to Part 15 of FCC rules. These limits are designed to provide reasonable protection against harmful interference when the equipment is operated in a commercial environment. This equipment generates uses and can radiate radio frequency energy and, if not installed and used in accordance with the instructions, may cause harmful interference to radio communications. However, there is no guarantee that interference will not occur in a particular installation. If this equipment does cause harmful interference to radio or television reception, which can be determined by turning the equipment off and on, the user is encouraged to try to correct the interference by one or more of the following measures:

1. Reorient or relocate the receiving antenna.
2. Increase the separation between the equipment and receiver.
3. The equipment and the receiver should be connected to outlets on separate circuits.
4. Consult the dealer or an experienced radio/television technician for help.

Changes or modifications not expressly approved by the party responsible for compliance could void the user's authority to operate the equipment.

If this telephone equipment causes harm to the telephone network, the telephone company will notify you in advance that temporary discontinuance of service may be required. But if advance notice isn't practical, the telephone company will notify the customer as soon as possible. Also, you will be advised of your right to file a complaint with the FCC if you believe it is necessary.

The telephone company may make changes in its facilities, equipment, operations or procedures that could affect the proper functioning of your equipment. If they do, you will be notified in advance in order for you to make necessary modifications to maintain uninterrupted service.

This equipment may not be used on coin service provided by the telephone company. Connection to party lines is subject to state tariffs.

**FCC Warning**



This equipment has been tested to comply with the limits for a **Class A** digital device, pursuant to Part 15 of the FCC Rules. These limits are designed to provide reasonable protection against harmful interference when the equipment is operated in a commercial environment. This equipment can generate, use, and radiate radio frequency energy and, if not installed and used in accordance with the instruction manual, may cause harmful interference to radio communications. Operation of this equipment in a residential area is likely to cause harmful interference in which case the user will be required to correct the interference at owner's expense.

**CE Mark Warning**



**This is a class B product.** In a domestic environment, this product may cause radio interference in which case the user may be required to take adequate measures.

**RoHS Warning**



RoHS stands for Restriction of Hazardous Substances, and impacts the entire electronics industry and many electrical products as well. The original RoHS, also known as Directive 2002/95/EC, originated in the European Union in 2002 and restricts the use of six hazardous materials found in electrical and electronic products. All applicable products in the EU market since July 1, 2006 must pass RoHS compliance. Directive 2011/65/EU was published in 2011 by the EU, which is known as RoHS-Recast or RoHS 2. RoHS 2 includes a **CE-marking directive**, with RoHS compliance now being required for CE marking of products. RoHS 2 also added Categories 8 and 9, and has additional compliance recordkeeping requirements. Directive 2015/863 was published in 2015 by the EU, which is known as RoHS 3. RoHS 3 adds four additional restricted substances (phthalates) to the list of six.

**WEEE Warning**



To avoid the potential effects on the environment and human health as a result of the presence of hazardous substances in electrical and electronic equipment, end users of electrical and electronic equipment should understand the meaning of the crossed-out wheeled bin symbol. Do not dispose of WEEE as unsorted municipal waste and have to collect such WEEE separately.

## Warranty

The original product that the owner delivered in this package will be free from defects in material and workmanship for one year parts after purchase.

There will be a minimal charge to replace consumable components, such as fuses, power transformers, and mechanical cooling devices. The warranty will not apply to any products which have been subjected to any misuse, neglect or accidental damage, or which contain defects which are in any way attributable to improper installation or to alteration or repairs made or performed by any person not under control of the original owner.

The above warranty is in lieu of any other warranty, whether express, implied, or statutory, including but not limited to any warranty of merchantability, fitness for a particular purpose or any warranty arising out of any proposal, specification or sample. We shall not be liable for incidental or consequential damages. We neither assume nor authorize any person to assume for it any other liability.

**WARNING**  
Warranty Void  
If Removed

### **WARNING:**

- 1.DO NOT TEAR OFF OR REMOVE THE WARRANTY STICKER AS SHOWN, OR THE WARRANTY IS VOID.**
- 2.WARRANTY VOID IF USE COMMERCIAL-GRADE POWER ADAPTER IS USED AT HARSH ENVIRONMENTS.**

**Chinese SJ/T 11364-2014**

部件名称	有毒有害物质或元素					
	铅(Pb)	汞(Hg)	镉(Cd)	六价铬[Cr(VI)]	多溴联苯(PBB)	多溴二苯醚(PBDE)
结构壳体	○	○	○	○	○	○
电路组	○	○	○	○	○	○
包装及配件	○	○	○	○	○	○
○：表示该有毒物质在该部件所有均质材料中的含量均在 GB/T 26572 标准规定的限量要求以下。 ×：表示该有毒物质至少在该部件的某均质材料中的含量超出 GB/T 26572 标准规定的限量要求。						

上述规范仅适用于中国法律